

# SMPM Connector RF-minimodules (Option Parts)

## ▶ Semi-Flexible Cables

SMPM/J-SMPM/J SXL-12F Cable Assy  
Waka No : 02YB608# □□□□

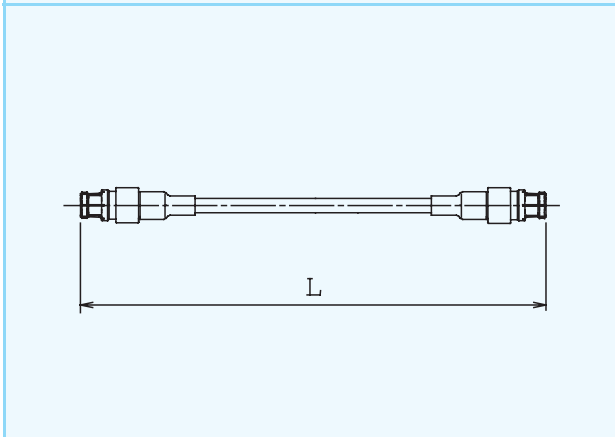
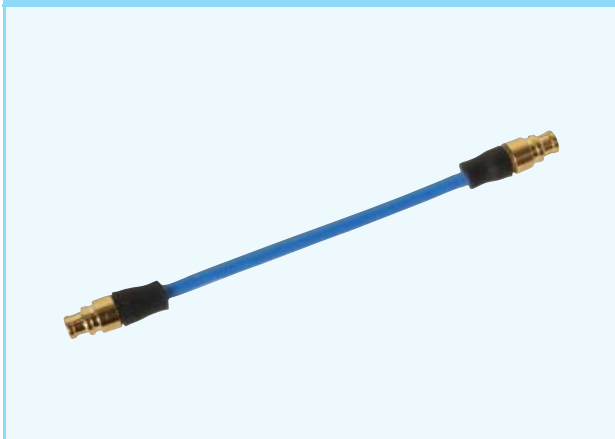

\* Standard length = 50,100,200(mm)

## Frequency Characteristics(S21,S11)

L≒50mm

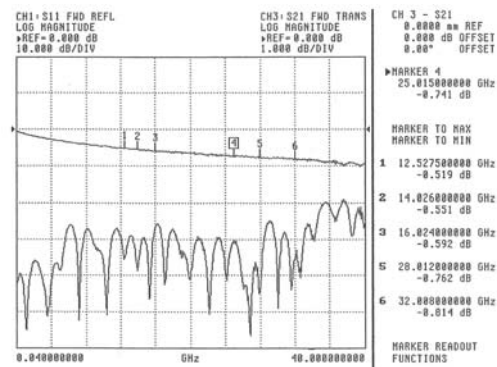

L≒200mm

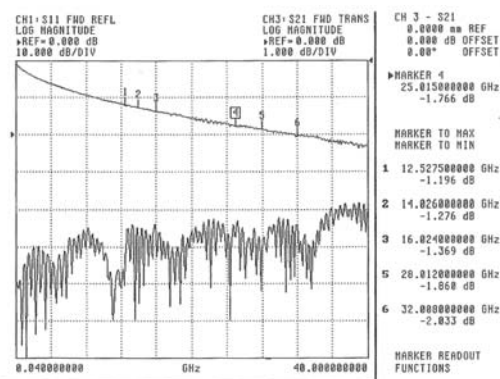

## ▶ Products Specification

| Requirement                     | Specification           |
|---------------------------------|-------------------------|
| Operating Frequency Range       | DC ~ 40GHz              |
| Characteristic Impedance        | 50 Ω                    |
| V.S.W.R.                        | Max 1.5                 |
| Contact Resistance              | DC 500V Min 5000M Ω     |
| Dielectric Withstanding Voltage | AC250V,rms at Sea Level |

\* As other series, We have also prepared 2.92mmK/J-SMPM/J Semi-Flexible Cables.



株式会社ワカ製作所  
WAKA MANUFACTURING CO.,LTD  
TEL : 03-6635-5410 FAX : 03-6635-5420  
URL: <http://www.waka.co.jp/>  
お問合せ : 営業部まで

▶ SMPM/J-J ADAPTERS

Waka No : 02R0216-00

Frequency Characteristics(S21,S11)

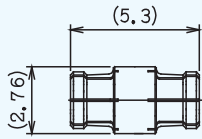

DC ~ 65GHz

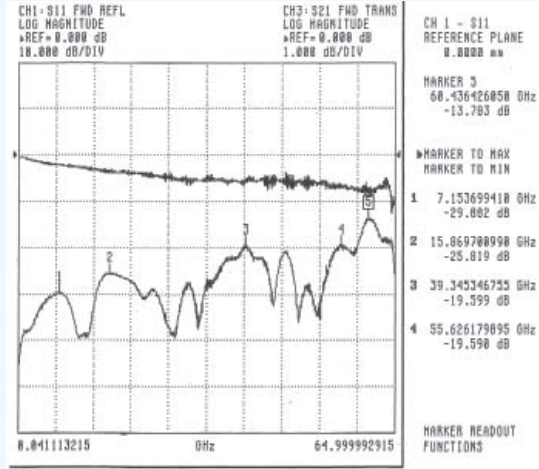

▶ SMPM/J-1.85mmV/J ADAPTERS

Waka No : 02R0220-00

Frequency Characteristics(S21,S11)

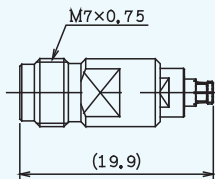

DC ~ 65GHz

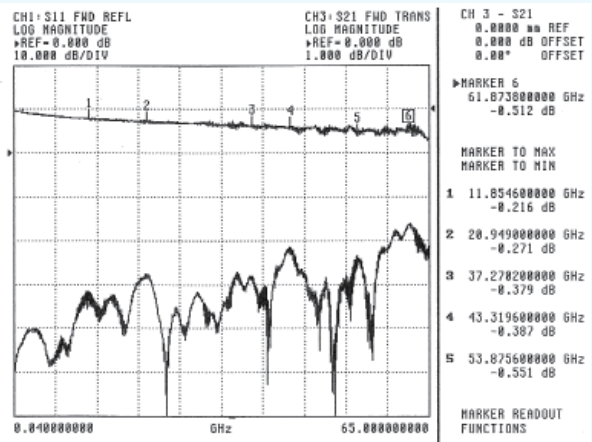

▶ SMPM Removal Tools

Waka No : 01S0922-00

Waka No : 01S1025-00

